



There is
so much to tell...







FEF3226L1

The wonderful feel of a burning log fire. The place where you can relax, meet, recharge your batteries and share. When a gas fire or wood stove is impossible or undesirable, or for those who prefer "individual design" and specific choices, Faber has the new e-MatriX; Astonishing fire... from water. Fire for anybody, anywhere.





Single-Sided Built-in Electric Firebox

- 
Logs
 Realistic charred log set to maximize the illusion of depth and the appearance of burning firewood. Combine with loose embers for a custom display.
- 
Water Connection
 Hard plumbed to provide consistent water flow.
- 
Light Module
 Provides a pulsating burn on logs for a truly lifelike effect.
- 
Sound Module
 Provides the soothing sounds of fire crackling.
- 
Rear Wall Steel
 Provides a solid dark interior finish.
- 
Remote Control
 Uses Bluetooth wireless technology to control all fireplace features from the comfort of your chair.



Product Dimensions:

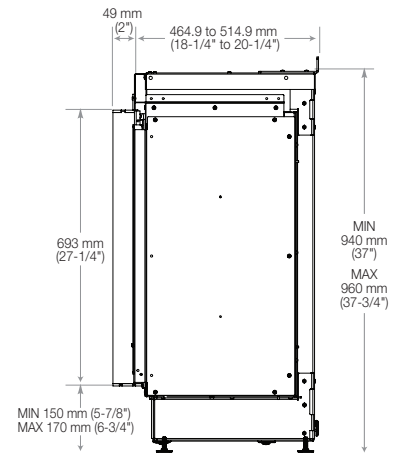
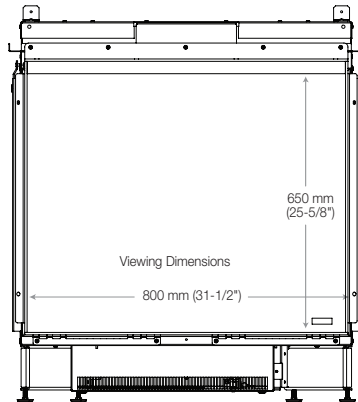
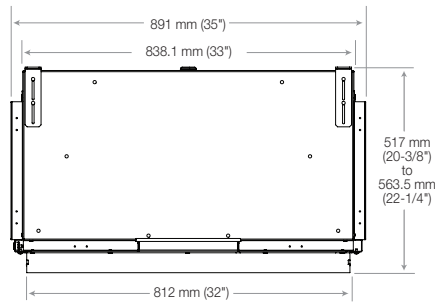

120 Volts | 270 Watts

Model #	Description	UPC	Wty. ¹	Water consumption	Power consumption	Inlet water pressure	Water connection	Carton Dimensions (WxHxD)		Cube		Lbs/ Kg
								inches	cm	Ft ³	M ³	
FEF3226L1	Single-Sided Firebox	781052 132016	5 yr.	0.30 L/hr 0.08 gal/hr	0.27 kW/hr	7.5 - 115 psi	1/4"	51 x 26 x 49	129.5 x 66.0 x 124.5	37.6	1.06	297 / 136

Specifications, finishes and dimensions are subject to change. ¹Limited warranty.
 ©2020 Glen Dimplex Americas
 SE-433-R03-070920

