



Better solutions through innovation

Service Manual

**Model Number:
DFR2651L**

**UL Part Number
6908932259**

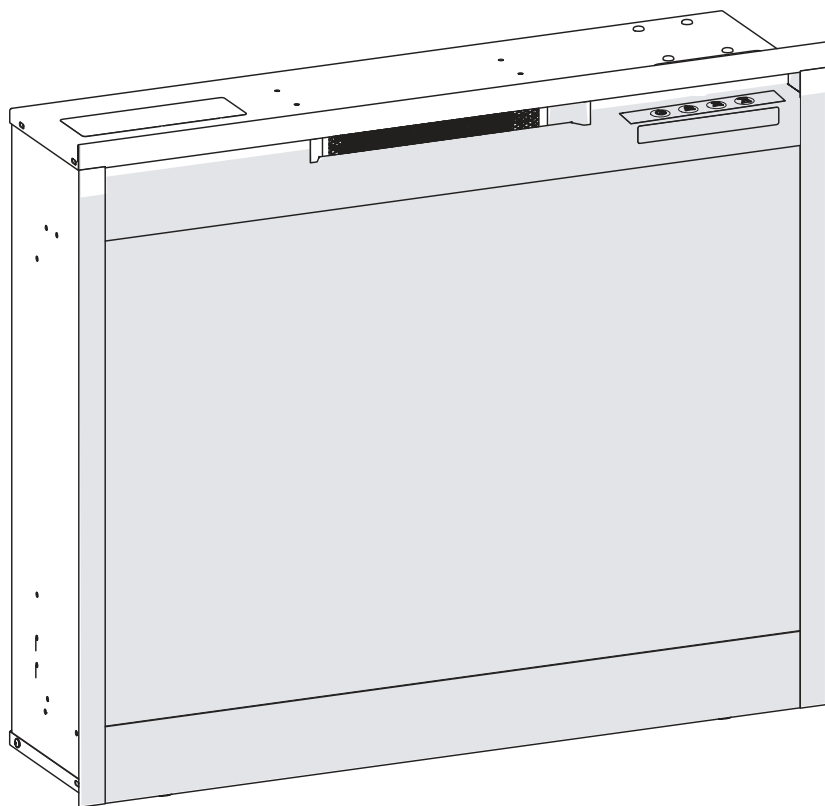

IMPORTANT SAFETY INFORMATION: Always read this manual first before attempting to service this fireplace. For your safety, always comply with all warnings and safety instructions contained in this manual to prevent personal injury or property damage.

Dimplex North America Limited
1367 Industrial Road • Cambridge ON Canada N3H 4W3
1-888-346-7539 • www.dimplex.com

In keeping with our policy of continuous product development, we reserve the right to make changes without notice.
© 2016 Dimplex North America Limited

REV	PCN	DATE
00	-	6-JAN-16

7400920100R00

TABLE OF CONTENTS

Operation	3
Maintenance	4
Exploded Parts Diagram	5
Replacement Parts	5
Wiring Diagram	6
Switchboard Replacement	7
Relay Board Replacement	7
AC/DC Adapter Replacement	8
Heater Assembly Replacement	8
Power Cord Replacement	8
Flicker Motor & Flicker Rod Replacement	9
Flame LED Light Assembly Replacement	9
Colored Flame LED Light Assembly Replacement	10
Log Set Assembly Replacement	10
Display/Control Board Replacement	11
Thermistor Replacement	11
Troubleshooting Guide	12

Always use a qualified technician or service agency to repair this fireplace.

! **NOTE:** Procedures and techniques that are considered important enough to emphasize.

⚠ **CAUTION:** Procedures and techniques which, if not carefully followed, will result in damage to the equipment.

⚠ **WARNING:** Procedures and techniques which, if not carefully followed, will expose the user to the risk of fire, serious injury, or death.

OPERATION

Figure 1

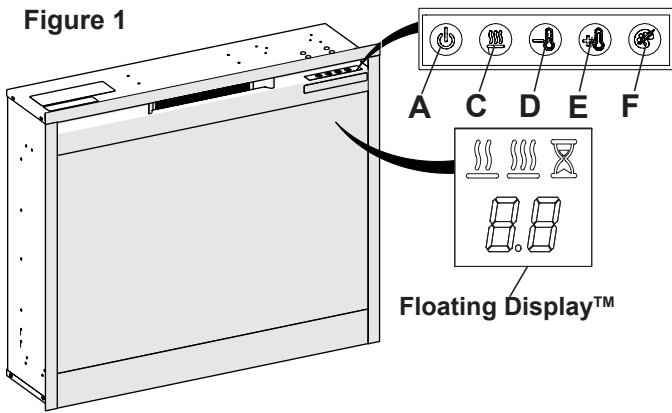

⚠ WARNING: This electric firebox must be properly installed before it is used.

The unit can be controlled by either the manual controls which are located on the upper right of the fireplace or the remote (Figure 1 & 2).

The fireplace is supplied with an IR multifunction remote control. This remote control has a range of approximately 16 ft (5 m). To operate correctly, the remote control must be pointed towards the Floating Display™.

! NOTE: Before attempting any operation with the remote, pull the plastic insulator strip out from between the remote casing and battery cover.

A. Standby

Turns the unit On and Off.

→ Activated by pressing the Standby button on the remote or the unit.

- The unit will turn on with the same functions that it was set to when it was turned Off and the intake temperature will be indicated on the On Screen Display.

! NOTE: When any button is pressed the intake temperature will be displayed on the On Screen Display for 5 seconds.

B. Flame Effects



Turns the flame effect On and Off.

→ Activated by pressing the  button on the remote.

C. Heat ON/OFF



Cycles the unit sequentially through the 3 settings: Low Heat, High Heat and Off.

→ Activated by pressing the  button on the unit or the remote.

- Indicated by the  (low heat) or the  (high heat) icon and the intake temperature being displayed on the On Screen Display, for 5 seconds before turning off.

! NOTE: After the heater is switched off, there is a 60 second fan delay, where the fan will continue running before turning off.

! NOTE: The unit can be operated in Heat Only Mode.



When the unit is only running with the heater, the  (low heat) or the  (high heat) icon and the intake temperature will continuously be displayed on the On Screen Display.

! NOTE: The heater may emit a slight, harmless odor when first used. This odor is a normal condition caused by initial heating of internal heater.



D & E. Thermostat Controls

Adjusts the temperature set point to your individual requirements. Once the desired set temperature is reached the heater will turn off. The heater will cycle on and off to maintain the desired set temperature. The default temperature setting is 72°F (22°C).

→ Adjusted by pressing the



 to decrease the setpoint and the  to increase the setpoint on the remote.



- The On Screen Display will indicate the temperature setpoint as it is adjusted.

! NOTE: Holding the  button down, then press  on the unit, will change the temperature from °C to °F, or vice versa.

Disable Heat

If desired, depending on the season, the heater on the unit can be disabled. The unit will operate in the same fashion, with remainder of the controls.

Pressing the  and  buttons on the unit at the same time and holding for 2 seconds will disable and enable the heater.

! NOTE: When the heater has been disabled and either the  or the  is pressed the On Screen Display will indicate "--".

F. Color Themes

Different presets of ambient lighting color combinations contained in the unit.

→ Changed by repeatedly pressing the corresponding button on the remote or the unit.

- Cycles through the different preset ambient lighting settings of the unit, this includes different combinations of colours of the flame and media lighting (if applicable).

! NOTE: The sixth theme of the cycle is a prism where the unit cycles through a variety of colours. Pressing the  button stops the cycling and holds the unit on the preferred color, indicated by a solid circle. When the unit is on prism, and is cycling through the colours, a rotating circle will be displayed.

G. Brightness

Changes the brightness of the lights in the unit.

→ Adjusted by repeatedly pressing the corresponding button on the remote.

- Indicated by the second digit on the Floating Display™

changing to show: "H" (high), and "L" (low).

H. Sleep Timer

The Sleep Timer can be set to automatically shut off the fireplace after a preset time (from 30 minutes to 8 hours).

- To set the timer press the timer button on either the remote or the unit, repeatedly, until the desired time is displayed.
- The On Screen Display will display the different times as it is adjusted. Once the timer has begun, pressing the  button will display the time remaining before the unit turns Off.

! NOTE: The Sleep Timer can be cancelled at any time by pressing the  button repeatedly until the sleep timer displays nothing.

Resetting the Temperature Cutoff Switch

Should the heater overheat, an automatic cut out will turn the heater off and it will not come back on without being reset. It can be reset by unplugging the unit and waiting 5 minutes before plugging the unit back in.

! CAUTION: If you need to continuously reset the heater, unplug the unit and call technical support at 1-888-346-7539.

Remote Control Battery Replacement

To replace the battery:

1. On the back of the remote control, slide battery cover open on the remote control.
2. Correctly install one 3 Volt (CR2032 [longer life] or CR2025) battery in the battery holder.
3. Close the battery cover.

 Battery must be recycled or disposed of properly. Check with your Local Authority or Retailer for recycling advice in your area

Figure 2



MAINTENANCE

! WARNING: Disconnect power before attempting any maintenance or cleaning to reduce the risk of fire, electric shock or damage to persons.

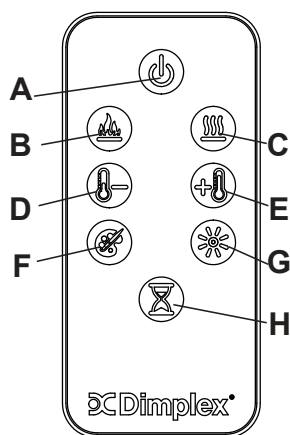
Glass Cleaning

The glass is cleaned in the factory during the assembly operation. During shipment, installation, handling, etc., the front glass panel may collect dust particles; these can be removed by dusting lightly with a clean dry cloth.

To remove fingerprints or other marks, the front glass panel can be cleaned with a damp cloth. The front glass panel should be completely dried with a lint free cloth to prevent water spots. To prevent scratching, do not use abrasive cleaners or spray liquids on the glass surface.

Fireplace Cleaning

Use warm water only to clean painted surfaces of the Compact Fireplace. Do not use abrasive cleaners.

To prolong the life of your unit and optimize the performance of your heater, vacuum or dust the outlet of the heater, and under and behind your firebox, on a regular basis.

Servicing

Except for the cleaning described above, an authorized service representative should perform any other servicing.

EXPLODED PARTS DIAGRAM

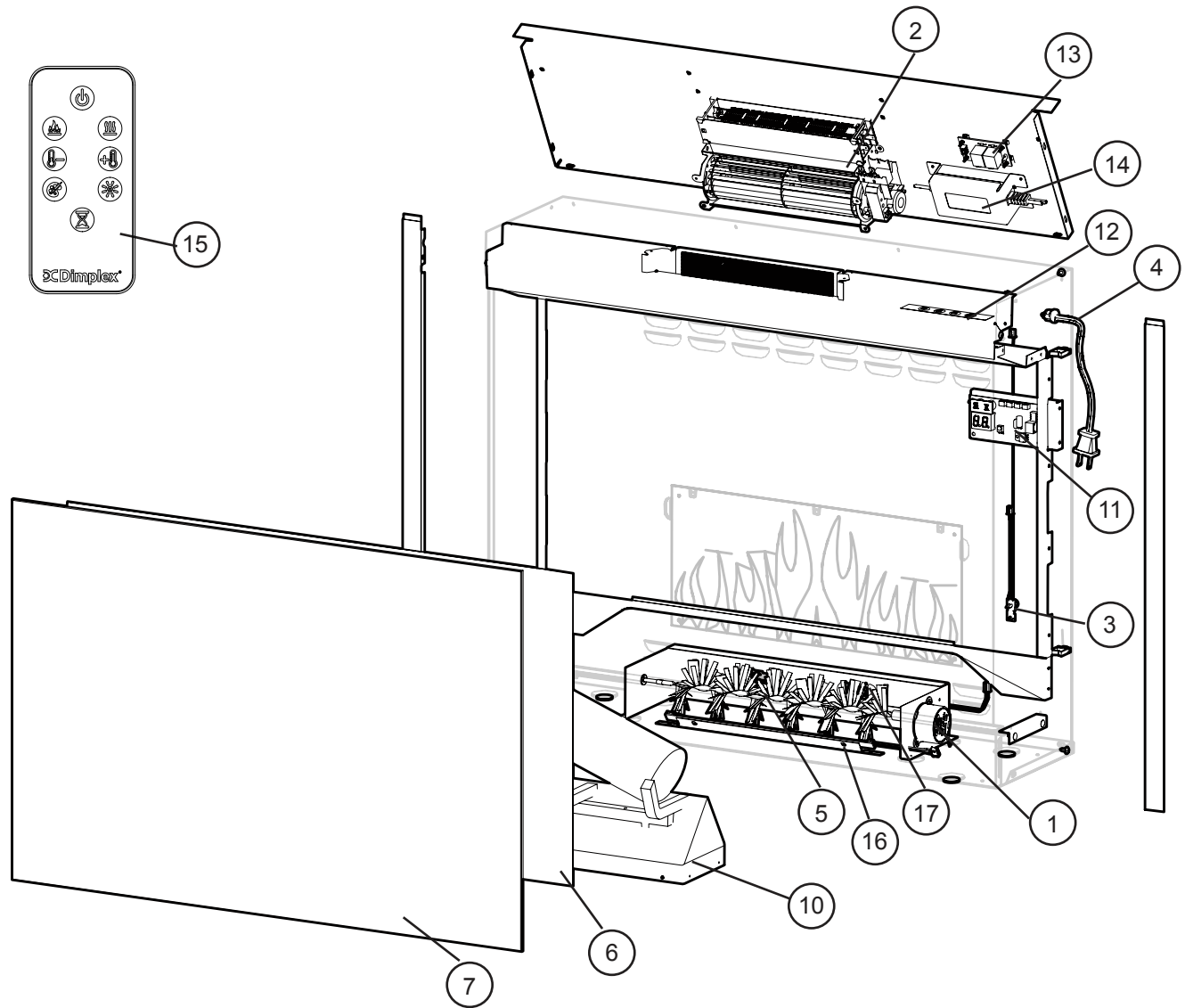

REPLACEMENT PARTS

1. Flicker Motor2000500100RP	10. Log Set Assembly0439560500RP
2. Ceramic Heater Assembly (with Cutout)	2203690100RP	11. Display/ Control Board3001430100RP
3. Thermistor.3001560100RP	12. Switchboard3001520100RP
4. Cord Set4100090204RP	13. Relay Board3001440100RP
5. Flicker Rod5902620100RP	14. AC/DC Adapter2100250100RP
6. Partially Reflective Panel5902580300RP	15. Remote Control.6700520200RP
7. Front Glass5902570200RP	16. Colored Flame LED Light Assembly . .	.3001500200RP
8. Felt Feet Pads (set of 4)8600140101RP	17. Flame LED Light Assembly.3001390100RP
9. Plastic Foot Set.8800090101RP	18. L-Bracket.1013780100RP

WIRING DIAGRAM

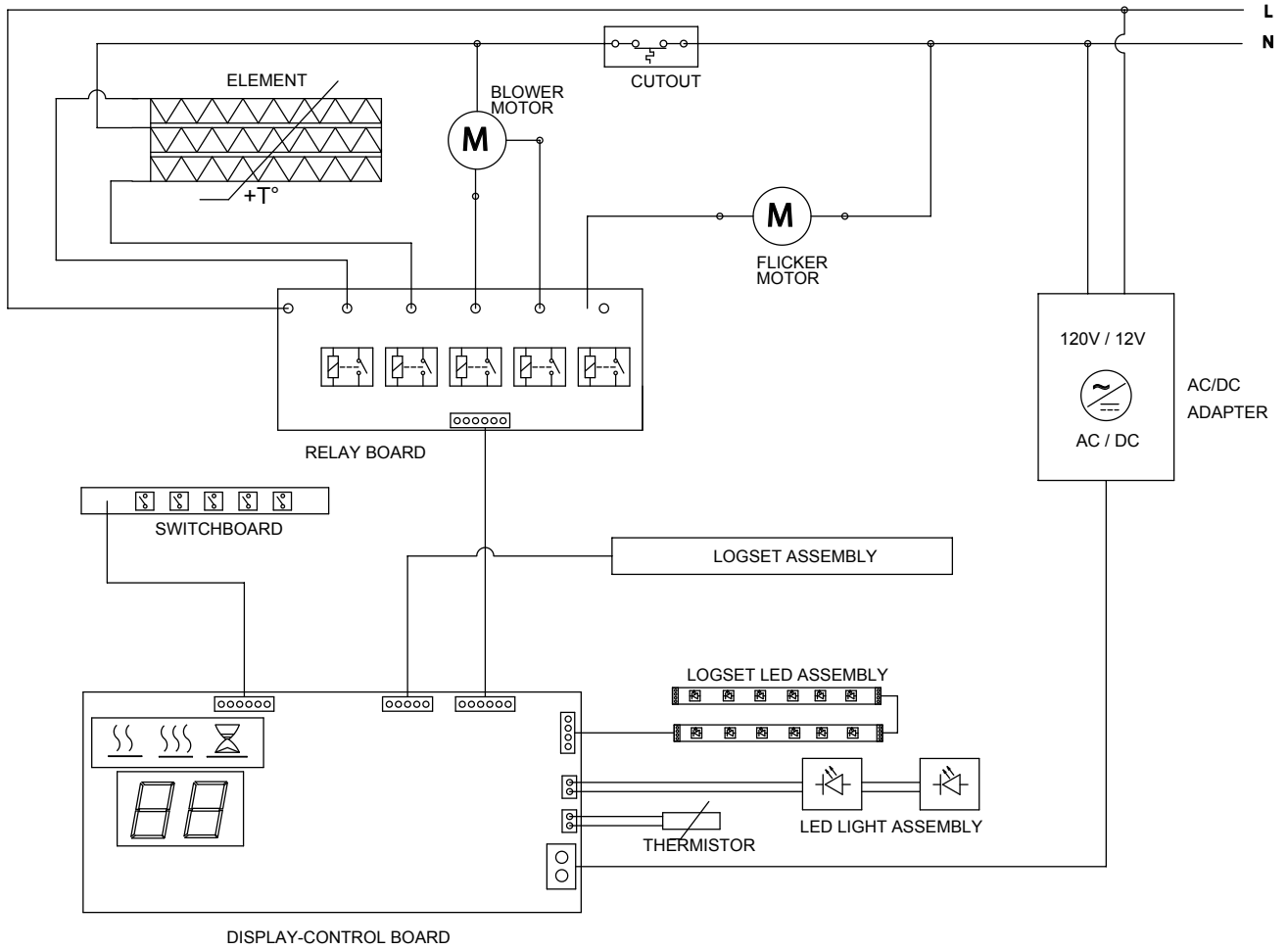

SWITCHBOARD REPLACEMENT

Tools Required: Phillips Head Screwdriver
Flat Head Screwdriver

CAUTION: If unit was operating prior to servicing allow at least 10 minutes for lights, heating elements and top panel to cool off to avoid accidental burning of skin.

WARNING: Disconnect power before attempting any maintenance to reduce the risk of electric shock or damage to persons.

1. Unplug the unit from power outlet.
2. Remove the firebox from the back of the mantel by removing the retaining screws which secure the firebox brackets to the mantel.
3. Remove the four screws along the back of the unit, the two on either side along the top edge and the two at the top of the glass retaining bracket on both sides. (Figure 3)
4. Lay the Compact Fireplace on its back.
5. Remove the six screws on the top surface. (Figure 3)
6. Gently open the top panel, laying it on the work surface so that all of the components can easily be seen. (Figure 4)

NOTE: The wires are grouped together with tie wraps, which may need to cut to fully open the top panel.

7. Locate the Main Power switch and disconnect the wiring connections noting their original locations.

NOTE: A flat head screwdriver can be used to gently pry between the end of the connector and the switch to release the wires.

8. Depress the retainer clips on the rear of the switch and push the switch out through the opening.
9. Properly orient and insert the new switch and connect

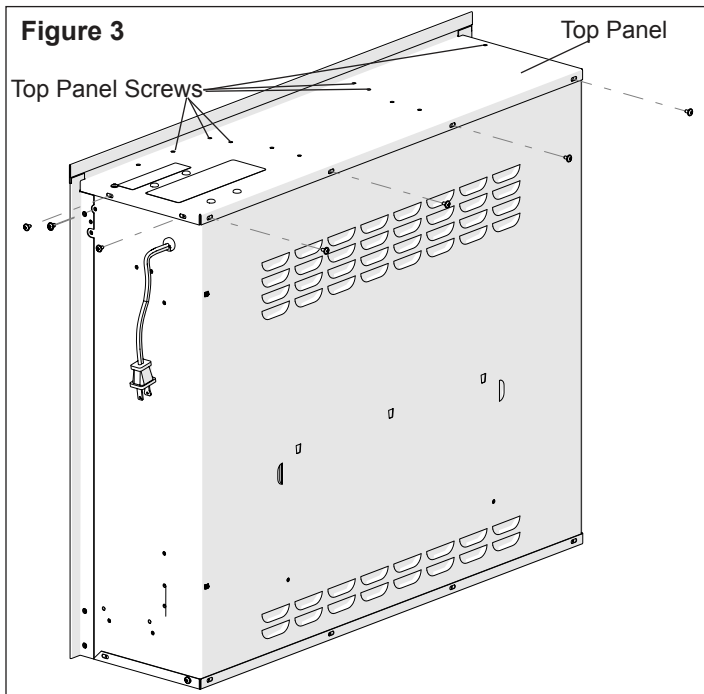

all of the wiring.

NOTE: If any tie wraps were removed, replace and ensure that none of the wires are pinched during reassembly.

10. Reassemble in the reverse order as above.

RELAY BOARD REPLACEMENT

Tools Required: Phillips Head Screwdriver
Flat Head Screwdriver
Needle Nose Pliers

CAUTION: If unit was operating prior to servicing allow at least 10 minutes for lights, heating elements and top panel to cool off to avoid accidental burning of skin.

WARNING: Disconnect power before attempting any maintenance to reduce the risk of electric shock or damage to persons.

1. Unplug the unit from power outlet.
2. Remove the firebox from the back of the mantel by removing the retaining screws which secure the firebox brackets to the mantel.
3. Remove the four screws along the back of the unit, the two on either side along the top edge. (Figure 3)
4. Lay the Compact Fireplace on its back.
5. Remove the six screws on the top surface. (Figure 3)
6. Gently open the top panel, laying it on the work surface so that all of the components can easily be seen. (Figure 4)

NOTE: The wires are grouped together with tie wraps, which may need to cut to fully open the top panel.

7. Locate the relay board and disconnect the wiring connections noting their original locations.

NOTE: A flat head screwdriver can be used to gently pry between the end of the connector and the switch to release the wires.

8. Release the relay board from the top panel by using needle nose pliers to depress the tab on the mounting

Figure 4

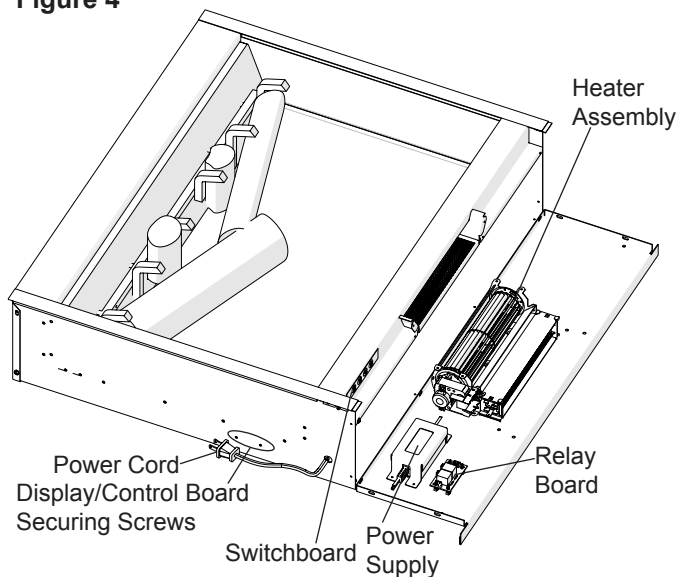

standoffs and gently lift the board off.

9. Properly orient and insert the new board and connect all of the wiring.

! **NOTE:** If any tie wraps were removed, replace and ensure that none of the wires are pinched during reassembly.

10. Reassemble in the reverse order as above.

AC/DC ADAPTER REPLACEMENT

Tools Required: Phillips Head Screwdriver
Flat Head Screwdriver

⚠ **CAUTION:** If unit was operating prior to servicing allow at least 10 minutes for lights, heating elements and top panel to cool off to avoid accidental burning of skin.

⚠ **WARNING:** Disconnect power before attempting any maintenance to reduce the risk of electric shock or damage to persons.

1. Unplug the unit from power outlet.
2. Remove the firebox from the back of the mantel by removing the retaining screws which secure the firebox brackets to the mantel.
3. Remove the four screws along the back of the unit, the two on either side along the top edge. (Figure 3)
4. Lay the Compact Fireplace on its back.
5. Remove the six screws on the top surface. (Figure 3)
6. Gently open the top panel, laying it on the work surface so that all of the components can easily be seen. (Figure 4)

! **NOTE:** The wires are grouped together with tie wraps, which may need to cut to fully open the top panel.

7. Locate the adapter and disconnect the wiring connections noting their original locations.
8. There is one connection located on the display/control board that requires the board to be removed. This can be done by removing the two screws on the right hand side of the unit, reaching between the partially reflective panel and the back of the unit, to remove the display/control board to remove the connection and replace it with the new one.
9. Reinstall the display/control board.
10. Remove the adapter from the top panel by removing the four screws securing it to the top panel.
11. Properly orient and insert the new adapter and connect all of the wiring.

! **NOTE:** If any tie wraps were removed, replace and ensure that none of the wires are pinched during reassembly.

12. Reassemble in the reverse order as above.

HEATER ASSEMBLY REPLACEMENT

Tools Required: Phillips Head Screwdriver
Flat Head Screwdriver

⚠ **CAUTION:** If unit was operating prior to servicing allow at least 10 minutes for lights, heating elements and top panel to cool off to avoid accidental burning of skin.

⚠ **WARNING:** Disconnect power before attempting any maintenance to reduce the risk of electric shock or damage to persons.

1. Unplug the unit from power outlet.
2. Remove the firebox from the back of the mantel by removing the retaining screws which secure the firebox brackets to the mantel.
3. Remove the four screws along the back of the unit, the two on either side along the top edge. (Figure 3)
4. Lay the Compact Fireplace on its back.
5. Remove the six screws on the top surface. (Figure 3)
6. Gently open the top panel, laying it on the work surface so that all of the components can easily be seen. (Figure 4)

! **NOTE:** The wires are grouped together with tie wraps, which may need to cut to fully open the top panel.

7. Locate the heater assembly and disconnect the wiring connections noting their original locations.

! **NOTE:** A flat head screwdriver can be used to gently pry between the end of the connector and the switch to release the wires.

8. Remove the 4 screws that secure the top panel to the heater assembly
9. Properly orient and install the new assembly and connect all of the wiring.

⚠ **WARNING:** Ensure wires do not come in contact with moving parts by securing wires in wiring tie wraps.

10. Reassemble in the reverse order as above.

POWER CORD REPLACEMENT

Tools Required: Phillips Head Screwdriver

⚠ **CAUTION:** If unit was operating prior to servicing allow at least 10 minutes for lights, heating elements and top panel to cool off to avoid accidental burning of skin.

⚠ **WARNING:** Disconnect power before attempting any maintenance to reduce the risk of electric shock or damage to persons.

1. Unplug the unit from power outlet.
2. Remove the firebox from the back of the mantel by removing the retaining screws which secure the firebox brackets to the mantel.
3. Remove the four screws along the back of the unit, the two on either side along the top edge. (Figure 3)
4. Lay the Compact Fireplace on its back.
5. Remove the six screws on the top surface. (Figure 3)
6. Gently open the top panel, laying it on the work sur-

face so that all of the components can easily be seen. (Figure 4)

! **NOTE:** The wires are grouped together with tie wraps, which may need to cut to fully open the top panel.

7. Locate the power cord and disconnect the wiring connections noting their original locations.

! **NOTE:** A flat head screwdriver can be used to gently pry between the end of the connector and the switch to release the wires.

8. With needle nose pliers, grasp the power cord strain relief grommet from inside the back of the bottom panel and push while twisting to remove.

9. Install the new power cord.

! **NOTE:** If any tie wraps were removed, replace and ensure that none of the wires are pinched during reassembly.

10. Reassemble in the reverse order as above.

FLICKER MOTOR & FLICKER ROD REPLACEMENT

Tools Required: Phillips Head Screwdriver

⚠ **CAUTION:** If unit was operating prior to servicing allow at least 10 minutes for lights, heating elements and top panel to cool off to avoid accidental burning of skin.

⚠ **WARNING:** Disconnect power before attempting any maintenance to reduce the risk of electric shock or damage to persons.

1. Unplug the unit from power outlet.
2. Remove the firebox from the back of the mantel by removing the retaining screws which secure the firebox brackets to the mantel.
3. Remove the four screws along the back of the unit, the two that hold the glass retaining bracket on both sides and the two on either side along the bottom edge. (Figure 5)

Figure 5

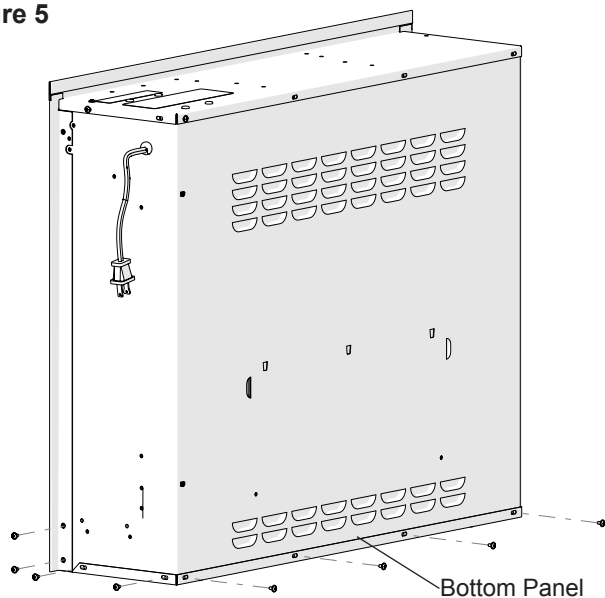

4. Lay the Compact Fireplace on its back.
5. Gently open the bottom panel, laying it on the work surface so that all of the components can easily be seen. (Figure 6)
6. Locate the flicker motor and flicker rod.
7. Locate and disconnect the 2 wires from the wire connectors.
8. Remove the 2 motor mounting screws.
9. Separate the motor from the flicker connector and remove.
10. Slide the flicker rod out of the snap-in bushing and remove.
11. Reassemble in the reverse order as above.

FLAME LED LIGHT ASSEMBLY REPLACEMENT

Tools Required: Phillips Head Screwdriver

⚠ **CAUTION:** If unit was operating prior to servicing allow at least 10 minutes for lights, heating elements and top panel to cool off to avoid accidental burning of skin.

⚠ **WARNING:** Disconnect power before attempting any maintenance to reduce the risk of electric shock or damage to persons.

1. Unplug the unit from power outlet.
2. Remove the firebox from the back of the mantel by removing the retaining screws which secure the firebox brackets to the mantel.
3. Remove the four screws along the back of the unit, the two that hold the glass retaining bracket on both sides and the two on either side along the bottom edge. (Figure 5)
4. Lay the Compact Fireplace on its back.
5. Gently open the bottom panel, laying it on the work surface so that all of the components can easily be seen. (Figure 6)
6. Locate and remove the LED lights along the back.
7. Disconnect the wiring connections noting their original location.

Figure 6

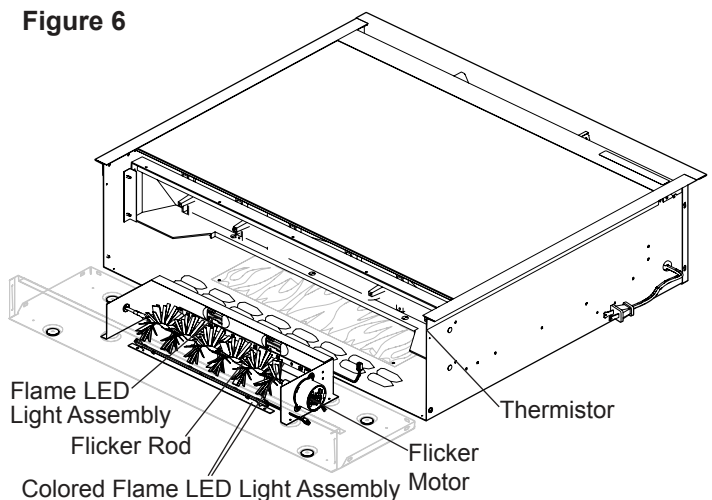

8. Properly orient and install the new LED lights and connect all of the wiring.
9. Reassemble in the reverse order as above.

COLORED FLAME LED LIGHT ASSEMBLY REPLACEMENT

Tools Required: Phillips Head Screwdriver

⚠ CAUTION: If unit was operating prior to servicing allow at least 10 minutes for lights, heating elements and top panel to cool off to avoid accidental burning of skin.

⚠ WARNING: Disconnect power before attempting any maintenance to reduce the risk of electric shock or damage to persons.

1. Unplug the unit from power outlet.
2. Remove the firebox from the back of the mantel by removing the retaining screws which secure the firebox brackets to the mantel.
3. Remove the four screws along the back of the unit, the two that hold the glass retaining bracket on both sides and the two on either side along the bottom edge. (Figure 5)
4. Lay the Compact Fireplace on its back.
5. Gently open the bottom panel, laying it on the work surface so that all of the components can easily be seen. (Figure 6)
6. Locate the strip of LED lights along the back and the strip of LED lights on the brack at the front.
7. Release the LED light strips from the support panels by using needle nose pliers to depress the tab on the mounting standoffs and gently lift the board off.
8. Disconnect the wiring connections noting their original location.
9. Properly orient and install the new LED lights and connect all of the wiring.
10. Reassemble in the reverse order as above.

Figure 7

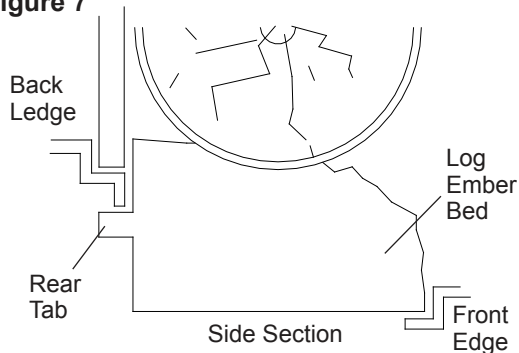

LOG SET ASSEMBLY REPLACEMENT

Tools Required: Phillips Head Screwdriver

⚠ CAUTION: If unit was operating prior to servicing allow at least 10 minutes for lights, heating elements and top panel to cool off to avoid accidental burning of skin.

⚠ WARNING: Disconnect power before attempting any maintenance to reduce the risk of electric shock or damage to persons.

1. Unplug the unit from power outlet.
 2. Remove the firebox from the back of the mantel by removing the retaining screws which secure the firebox brackets to the mantel.
 3. On the right side, remove the three screws to remove the trim off of the unit.
 4. Remove the front glass and set aside in a safe place.
 5. Pull the front edge of the plastic Ember Bed or plastic grate up and forward until the rear tab releases from the ledge located at the bottom of the Partially Reflective Panel. (Figure 7)
- ! IMPORTANT:** Only handle the Log Set by the Ember Bed.
- ! NOTE:** Log Set fits tightly into firebox, some force may be necessary to remove.
6. Disconnect the wiring connections noting their original location.
 7. Remove the two screws on each side that secure the log set support brackets to the firebox remove the partially reflective panel by sliding it out of the side channels towards the bottom. (Figure 7)
 8. Reassemble in the reverse order as above.

Figure 8

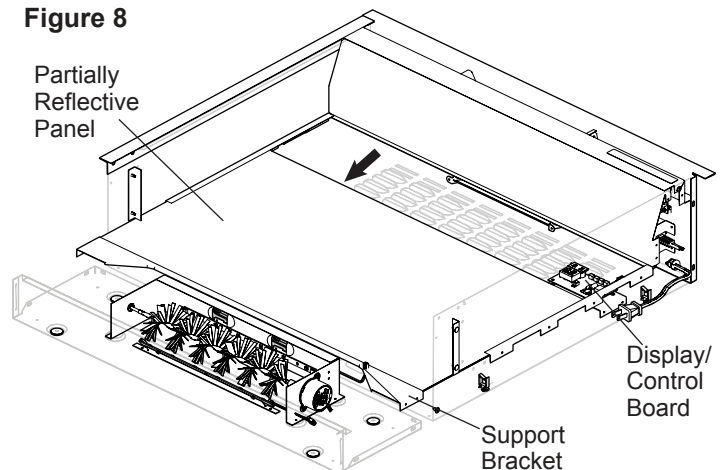

DISPLAY/CONTROL BOARD REPLACEMENT

Tools Required: Phillips Head Screwdriver
Flat Head Screwdriver
Needle Nose Pliers

⚠ CAUTION: If unit was operating prior to servicing allow at least 10 minutes for lights, heating elements and top panel to cool off to avoid accidental burning of skin.

⚠ WARNING: Disconnect power before attempting any maintenance to reduce the risk of electric shock or damage to persons.

1. Unplug the unit from power outlet.
2. Remove the firebox from the back of the mantel by removing the retaining screws which secure the firebox brackets to the mantel.
3. On the right side, remove the three screws to remove the trim off of the unit.
4. Remove the front glass and set aside in a safe place.
5. Remove the four screws along the bottom, back of the unit and the two on either side along the bottom edge. (Figure 5)
6. Lay the Compact Fireplace on its back.
7. Gently open the bottom panel, laying it on the work surface so that all of the components can easily be seen. (Figure 6)
8. Lift the log set assembly, gently out of the unit, being careful not to strain any of the connections and place on the bottom panel assembly.

! IMPORTANT: Only handle the Log Set by the Ember Bed.

9. Locate and remove the support bracket for the partially reflective panel (Figure 8), secured with two screws on either end.
10. Slide the partially reflective panel down until the display/control board is visible
11. Panel can be removed by sliding down and gently lifting up in the middle until comes out of brackets on either side.
12. Locate the display/control board behind the partially reflective panel and remove the two screws that attach the support bracket to the unit.
13. Disconnect the wiring connections noting their original locations.
14. Release the display/control board from the support panel by using needle nose pliers to depress the tab on the mounting standoffs and gently lift the board off.
15. Properly orient and insert the new board and connect all of the wiring.
16. Reassemble in the reverse order as above.

THERMISTOR REPLACEMENT

Tools Required: Phillips Head Screwdriver
Flat Head Screwdriver
Needle Nose Pliers

⚠ CAUTION: If unit was operating prior to servicing allow at least 10 minutes for lights, heating elements and top panel to cool off to avoid accidental burning of skin.

⚠ WARNING: Disconnect power before attempting any maintenance to reduce the risk of electric shock or damage to persons.

1. Unplug the unit from power outlet.
 2. Remove the firebox from the back of the mantel by removing the retaining screws which secure the firebox brackets to the mantel.
 3. On the right side, remove the three screws to remove the trim off of the unit.
 4. Remove the front glass and set aside in a safe place.
 5. Remove the four screws along the bottom, back of the unit and the two on either side along the bottom edge. (Figure 5)
 6. Lay the Compact Fireplace on its back.
 7. Gently open the bottom panel, laying it on the work surface so that all of the components can easily be seen. (Figure 6)
 8. Lift the log set assembly, gently out of the unit, being careful not to strain any of the connections and place on the bottom panel assembly.
- ! IMPORTANT:** Only handle the Log Set by the Ember Bed.
9. Locate and remove the support bracket for the partially reflective panel (Figure 8), secured with two screws on either end.
 10. Slide the partially reflective panel down until the display/control board is visible
 11. Remove the partially reflective panel by sliding the panel down and gently lifting up in the middle until comes out of brackets on either side.
 12. Locate the thermistor behind the partially reflective panel.
 13. Disconnect the wiring connections noting their original locations.
 14. Release the thermistor by using needle nose pliers to depress the tab on the mounting standoffs and gently lift the board off.
 15. Properly orient and insert the new board and connect all of the wiring.
 16. Reassemble in the reverse order as above.

TROUBLESHOOTING GUIDE

PROBLEM	CAUSE	SOLUTION	PART NUMBER
General			
Circuit breaker trips or fuse blows when unit is turned on	Short in unit wiring.	Trace wiring in unit.	
	Improper circuit current rating	Additional appliances may exceed the current rating of the circuit breaker or fuse. Plug unit into another outlet or install unit on a dedicated 15 amp circuit.	
Lights dim in room while the unit is on	Unit is drawing close to circuit current rating	Move the unit to another outlet or install unit on a dedicated 15 amp circuit	
Power cord gets warm	Normal Operation	The power cord may get slightly warm to the touch when the heater is on	
	Defective power cord	Replace power cord if cord gets hot to the touch.	4100090204RP
Appearance			
Fireplace does not turn on with manual controls	Improper operation	Refer to Operation Section	
	No incoming voltage from the electrical wall socket	Check Fuse/Breaker Panel	
	Loose wiring	Check wiring connections	
	Defective switchboard	Replace the switchboard	3001520100RP
	Defective display/control board	Replace the display/control board	3001430100RP
	Defective relay board	Replace the relay board	3001440100RP
Defective AC/DC adapter	Replace the AC/DC adapter	2100250100RP	
Fireplace does not turn on with the Remote Control	Improper operation	Refer to Operation Section	
	The batteries in the remote control are dead.	Install new battery into the remote control.	
	Defective display/control board	Replace the display/control board	3001430100RP
Display is flashing	Loose wiring	Check wiring connections	
	Defective AC/DC adapter	Replace the AC/DC adapter	2100250100RP
	Defective display/control board	Replace the display/control board	3001430100RP
Display has a "PF" showing	Loose connection of the thermistor	Check wiring connection	
	Defective thermistor	Replace the thermistor	3001560100RP
Display has "= =" showing	The ambient temperature around the unit is too low ($\leq 32^{\circ}\text{F}/0^{\circ}\text{C}$)	Allow the heater to run for 10-15 minutes to allow the motor to heat up the enclosure and begin to operate normally.	
Flame Frozen	Loose wiring	Check wiring connections	
	Defective Flicker Motor	Replace Flicker Motor	2000500100RP
Flame is not visible	Loose wiring	Check wiring connections	
	Flame LED Light Assembly is not working	Replace Flame LED Light Assembly	3001390100RP
	Defective display/control board	Replace the display/control board	3001430100RP
Coloured flames are not working	Loose wiring	Check wiring connections	
	Colored Flame LED Light Assembly is not working	Replace Colored Flame LED Light Assembly	3001500200RP
	Defective display/control board	Replace the display/control board	3001430100RP
Flame Shudder	Defective Flicker Motor	Replace Flicker Motor	2000500100RP
Light leaking around the log set (if applicable)	Log set not positioned properly	Check log set for proper fit	

PROBLEM	CAUSE	SOLUTION	PART NUMBER
Heater			
Heater is not turning off	Improper operation	Refer to Operation Section	
	Defective switchboard	Replace switchboard	3001520100RP
	Defective thermistor	Replace thermistor	3001560100RP
	Defective relay board	Replace the relay board	3001440100RP
	Defective display/control board	Replace the display/control board	3001430100RP
Heater is not turning on, but flame effect is still functioning	Improper operation	Refer to Operation Section	
	The ambient temperature around the unit is too low ($\leq 32^{\circ}\text{F}/0^{\circ}\text{C}$)	Allow the heater to run for 10-15 minutes to allow the motor to heat up the enclosure and begin to operate normally.	
	Loose wiring	Trace wiring in unit	
	Defective switchboard	Replace switchboard	3001520100RP
	Defective heater assembly	Replace heater assembly	2203690100RP
	Defective display/control board	Replace the display/control board	3001430100RP
Heater is turning off after a couple of minutes of operation	Build up of dirt/dust in Heater Assembly	Ensure that exterior intake louvers and fire-box cavity are free of dirt/dust.	
	Defective heater assembly	Replace heater assembly	2203690100RP
Heater emits an odor	Normal Operation	Normal operation is when the heater emits an odor for a brief period after the heater is initially turned on. The heater is burning off any dust accumulated during manufacturing or operation.	
	Defective heater assembly	Replace heater assembly	2203690100RP
Heating element is glowing red	Normal Operation	Small glowing sections of the element are considered normal.	
	Defective heater assembly	If larger glowing sections are causing the heater to trip the thermal cutout, unplug unit, discontinue use and replace heater assembly.	2203690100RP
Noise			
Excessive noise with the heater on	Dirty Heater Assembly	Ensure that exterior intake louvers and fire-box cavity are free of dirt/dust.	
	Defective heater assembly	Replace heater assembly	2203690100RP
Grinding or excessive noise with the heater off	Flicker rod hitting or rubbing against internal components	Ensure rod is straight and mounted properly in the bracket, spinning freely away from other components. Replace if necessary.	
	Defective Flicker Motor	Replace Flicker Motor	2000500100RP