

Owner's Manual

Model
DF3015







IMPORTANT SAFETY INFORMATION: Always read this manual first before attempting to install or use this fireplace. For your safety, always comply with all warnings and safety instructions contained in this manual to prevent personal injury or property damage.

To view the full line of Dimplex products, please visit
www.dimplex.com

7207500100R13



Table of Contents

	Welcome & Congratulations.	3
	IMPORTANT INSTRUCTIONS	4
	Fireplace Installation	7
	Operation	9
	Maintenance.	14
	Warranty.	18
	Replacement Parts.	21

Always use a qualified technician or service agency to repair this fireplace.

! NOTE: Procedures and techniques that are considered important enough to emphasize.

⚠ CAUTION: Procedures and techniques which, if not carefully followed, will result in damage to the equipment.

⚡ WARNING: Procedures and techniques which, if not carefully followed, will expose the user to the risk of fire, serious injury, or death.

Welcome & Congratulations

Thank you and congratulations for choosing to purchase an electric fireplace from Dimplex, the world leader in electric fireplaces.

Please carefully read and save these instructions.

⚠ CAUTION: Read all instructions and warnings carefully before starting installation. Failure to follow these instructions may result in a possible electric shock, fire hazard and will void the warranty.

Please record your model and serial numbers below for future reference: model and serial numbers can be found on the Model and Serial Number Label of your fireplace.

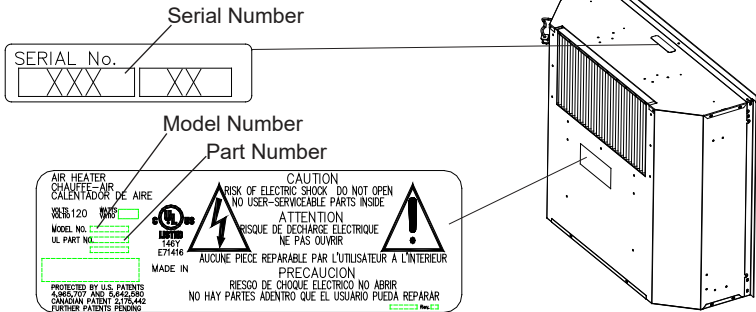

NO NEED TO RETURN TO THE STORE

Questions with operation or assembly? Require Parts Information?
Product Under Manufacturer's Warranty?

Contact us at:  www.dimplex.com/customer_support
For Troubleshooting and Technical Support

OR  **Toll-Free 1-888-DIMPLEX (1-888-346-7539)**
Please have your model number and
product serial number ready. (See above)

IMPORTANT INSTRUCTIONS

When using electrical appliances, basic precautions should always be followed to reduce the risk of fire, electric shock, and injury to persons, including the following:

- ① Read all instructions before using this appliance.
- ② The heater is hot when in use. To avoid burns, do not let bare skin touch hot surfaces. The trim around the heater outlet becomes hot during heater operation. Keep combustible materials, such as furniture, pillows, bedding, papers, clothes, and curtains at least 3' (0.9m) from the front of the unit.
- ③ Extreme caution is necessary when any heater is used by or near children or invalids and whenever the unit is left operating and unattended.
- ④ Always unplug the fireplace when not in use.
- ⑤ Do not operate any heater after it malfunctions. Disconnect power at the service panel and have the heater inspected by a reputable electrician before reusing.
- ⑥ Do not operate any unit with a damaged cord or plug, or if the heater has malfunctioned, or if the electric fireplace has been dropped or damaged in any manner, contact Dimplex Technical Service at 1-888-346-7539.
- ⑦ Do not use outdoors.
- ⑧ The fireplace is not intended for use in bathrooms, laundry areas and similar indoor locations. Never locate heater where it may fall into a bathtub or other water container.
- ⑨ Do not run the cord under carpeting. Do not cover cord with throw rugs, runners or the like. Arrange cord away from traffic area and where it will not be tripped over.
- ⑩ To disconnect the unit, turn the controls off, then remove the plug from the outlet.
- ⑪ Do not insert or allow foreign objects to enter any ventilation or exhaust opening as this may cause an electric shock or fire, or damage to the heater.

IMPORTANT INSTRUCTIONS

- ⑫ To prevent a possible fire, do not block air intake or exhaust in any manner.
- ⑬ All electrical heaters have hot and arcing or sparking parts inside. Do not use in areas where gasoline, paint, or flammable liquids are used or stored.
- ⑭ Do not modify the fireplace. Use it only as described in this manual. Any other use not recommended by the manufacturer may cause fire, electric shock or injury to persons.
- ⑮ Always plug heaters directly into a wall outlet/receptacle. Never use with an extension cord or relocatable power tap (outlet/power strip).
- ⑯ Do not burn wood or other materials in the fireplace.
- ⑰ Do not strike the fireplace glass.
- ⑱ Always use a certified electrician should new circuits or outlets be required.
- ⑲ Always use properly grounded, fused and polarized outlets.
- ⑳ Disconnect all power supply before performing any cleaning, maintenance or relocation of the unit.
- ㉑ When transporting or storing the unit and cord, keep in a dry place, free from excessive vibration and store so as to avoid damage.



CAUTION
RISK OF ELECTRIC SHOCK
DO NOT OPEN
NO USER-SERVICEABLE PARTS INSIDE



SAVE THESE INSTRUCTIONS

IMPORTANT INSTRUCTIONS

 **CAUTION:** This equipment has been tested and found to comply with the limits for a Class B digital device, pursuant to Part 15 of the FCC Rules. These limits are designed to provide reasonable protection against harmful interference in a residential installation. This equipment generates uses and can radiate radio frequency energy and, if not installed and used in accordance with the instructions, may cause harmful interference to radio communications. However, there is no guarantee that interference will not occur in a particular installation. If this equipment does cause harmful interference to radio or television reception, which can be determined by turning the equipment off and on, the user is encouraged to try to correct the interference by one of the following measures:

- Reorient or relocate the receiving antenna.
- Increase the separation between the equipment and receiver.
- Connect the equipment into an outlet on a circuit different from that to which the receiver is connected.
- Consult the dealer or an experienced radio/TV technician for help.

This device complies with Part 15 of the FCC Rules. Operation is subject to the following two conditions: (1) This device may not cause harmful interference, and (2) this device must accept any interference received, including interference that may cause undesired operation.

 **FCC CAUTION:** Any changes or modifications not expressly approved by the party responsible for compliance could void the user's authority to operate this equipment.

This device complies with Industry Canada licence-exempt RSS standard(s). Operation is subject to the following two conditions: (1) this device may not cause interference, and (2) this device must accept any interference, including interference that may cause undesired operation of the device.

Under Industry Canada regulations, this radio transmitter may only operate using an antenna of a type and maximum (or lesser) gain approved for the transmitter by Industry Canada. To reduce potential radio interference to other users, the antenna type and its gain should be so chosen that the equivalent isotropically radiated power (e.i.r.p.) is not more than that necessary for successful communication.

 **WARNING:** Remote control contains small batteries. Keep away from children. If swallowed, seek medical attention immediately.

 **WARNING:** Do not install battery backwards, charge, put in fire or mix with used or other battery types - may explode or leak causing injury.

 **NOTE:** Changes or modifications not expressly approved by the party responsible for compliance could void user's authority to operate the equipment.

Fireplace Installation

⚠ WARNING: Ensure the power cord is not installed so that it is pinched or against a sharp edge and ensure that the power cord is stored or secured to avoid tripping or snagging to reduce the risk of fire, electric shock or injury to persons.

⚠ WARNING: Construction and electrical outlet wiring must comply with local building codes and other applicable regulations to reduce the risk of fire, electric shock and injury to persons.

⚠ CAUTION: Clearance for air circulation beneath the fireplace insert is provided by two rubber feet.

Do not install the fireplace insert directly on carpet or similar surfaces which may restrict air circulation.

⚠ CAUTION: If installing the fireplace in a carpeted area, place a one-piece, solid, flat surface under the fireplace. Ensure that both of the feet rest securely on this surface.

! NOTE: The dimensions of the fireplace are 30¼" (768 mm) wide x 25½" (648 mm) high x 10½" (267 mm) deep.

The viewing area is 30⅞" (765 mm) wide and 20⅞" (511 mm) high. The fireplace does not require any additional venting. (See Figure 1 for recommended installation clearances.)

Mantel Installation

Install the fireplace assembly into the mantel (refer to mantel assembly instructions).

Figure 1

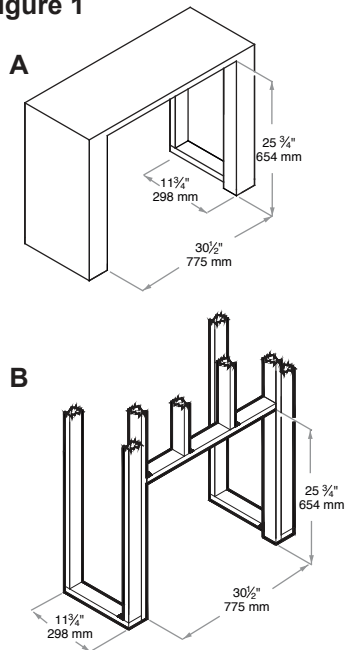

Fireplace Installation

! **IMPORTANT:** If not using a Dimplex mantel, the fireplace must be installed in an enclosure with the following **MINIMUM** internal/opening dimensions (Figure 1A).

New Wall Construction

1. Mark the desired location on the floor and store the fireplace in a safe, dry and dust free location.
2. Use studs to frame an opening of 30½" (775 mm) wide x 25¾" (654 mm) high x 11¾" (298) deep. (Figure 1B)
3. Plug the unit into a 15 Amp/ 120 Volt outlet.

Option #1: The power cord can be lead from behind the trim and along the wall to an outlet near the fireplace.

Option #2: A new outlet can be installed inside the new frame construction.

! **NOTE:** A 15 Amp, 120 Volt circuit is required. A dedicated circuit is preferred but not essential in all cases. A dedicated circuit will be required if, after installation, the circuit breaker trips or fuse blows on a regular basis when the heater is operating. Additional appliances on the same circuit may exceed the current rating of the circuit breaker.

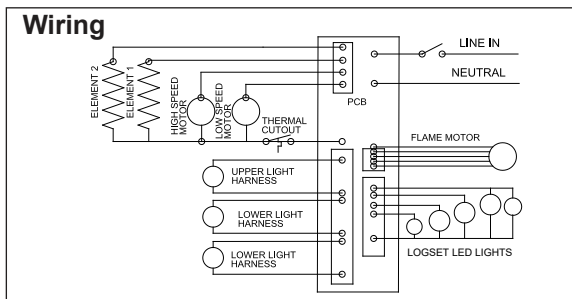

👉 Operation

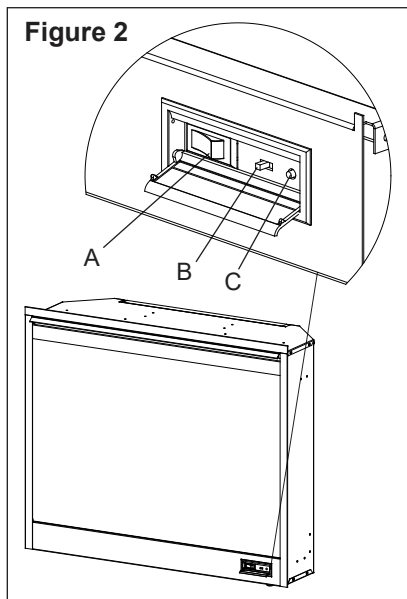

⚠ WARNING: This electric firebox must be properly installed before it is used.

Manual Controls

The manual controls for the fireplace are located in the lower right hand corner (Figure 2).

A. Main On/Off Switch

Supplies power to the 3-Position Switch.

B. 3-Position Switch

- **Remote (right position):**
The unit is operated with the remote control.

- **Flame (center position):**
The flame effect is turned on.
- **Flame & Heat (left position):**
The flame effect and heater are turned on simultaneously. When the manual control is in the **Flame & Heat** position the heater does not run on the remote operated thermostat.

! NOTE: When the manual control switch is in the **Flame** and **Flame & Heat** positions, the fireplace unit will not operate with the remote control.

C. Initialization Button

Used to synchronize the supplied remote control with the fireplace.

! NOTE: The heater on your fireplace may emit a slight, harmless odor when first used. This odor is a normal condition caused by the initial heating of internal heater parts and will not occur again.

Resetting The Temperature Cutoff Switch

Should the heater overheat, an automatic switch will turn the heater off and it will not come back on without being reset.

Operation

The temperature cutoff switch can be reset by unplugging the unit, waiting five (5) minutes and plugging the unit back in.

⚠ CAUTION: If you need to continuously reset the heater, unplug the unit and call Dimplex North America Limited at 1-888-346-7539. Please have your model and serial number ready when calling.

Remote Control

The remote control has a range of approximately 50' (15.25 m), it does not have to be pointed at the fireplace and can pass through most obstacles (including walls). It is supplied with 243 independent frequencies to prevent interference with other units.

Battery Installation

1. Depress tab on the battery cover on the back of the remote control and remove battery cover.
2. Install two AAA batteries into the remote control (included).
3. Ensure Child Lock is in the “unlocked” position (Figure 3).
4. Replace the battery cover.

Figure 3

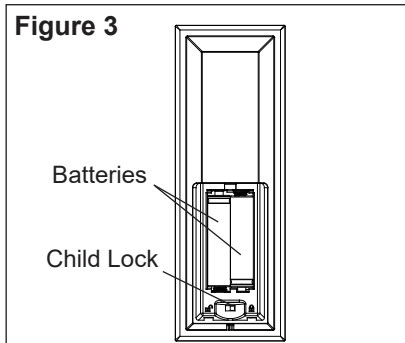

! NOTE: When the “BAT” symbol is present on the remote control it is recommended to replace the batteries promptly, to maintain full functionality of the remote/fireplace. The remote transmitter has a battery backup time of only several hours.







Battery must be recycled or disposed of properly. Check with your Local Authority or Retailer for recycling advice in your area.

Remote Control Initialization/ Reprogramming

1. Plug cord into a 120 Volt wall outlet.
2. Ensure the Main On/Off Switch located in the switch box on the fireplace in the lower right hand corner is in the On — position.

Operation

3. Set the 3-Position Switch (Figure 2B) to the **Remote** position (right position).
4. Press and hold the Initialization Button on the unit (Figure 2C).
5. While holding the Initialization Button, press the Flame/Heat On/Off button  or the Fan On/Off button  on the remote control.
6. Release the Initialization Button on the unit.
7. Press the Flame/Heat On/Off button  to turn the Flame/Heat function on or press the Fan On/Off button  to turn the Fan function on.

Remote Control Functions

(All letter references are to Figure 4)

B. Set Temperature

Press **H** button  to turn fireplace on.

Press **J** to raise thermostat, or **I** to lower the thermostat.

Press both **J** and **I** to change °F to °C.

C. Light Dimmer Control

Press the  button to turn the Flame & Heat on.

Repeatedly press the **L** or **K** button to increase or decrease

the brightness of the upper lights.

D. Flame Speed Control

Press the  button to turn the Flame & Heat on.

Press the **N** button to increase the speed of the flame.

Press the **M** button to decrease the speed of the flame.

E. Sleep Timer

The Sleep Timer automatically shuts off the fireplace after a preset time (from 30 minutes to 8 hours).

During fireplace operation, to set the sleep timer press the **P** button. Set the timer from 30 minutes through 8 hours. The fireplace will automatically turn off when the sleep timer reaches zero (0) minutes.

The sleep timer can be cancelled at any time by pressing the **O** button repeatedly until the sleep timer displays nothing.

F. Fan

When the **Fan** function is on, the **Fan** symbol will flash. When off the symbol will be

🔑 Operation

Figure 4 - Remote Control Functions

- A. Room Temperature
- B. Set Temperature
- C. Light Dimmer Control
- D. Flame Speed Control
- E. Sleep Timer
- F. Fan
- G. Fan On/Off
- H. Flame & Heat On/Off
- I. Temperature Down
- J. Temperature Up
- K. Dimmer Down
- L. Dimmer Up
- M. Flame Speed Down
- N. Flame Speed Up
- O. Sleep Timer Down
- P. Sleep Timer Up
- Q. Fan Speed Down
- R. Fan Speed Up

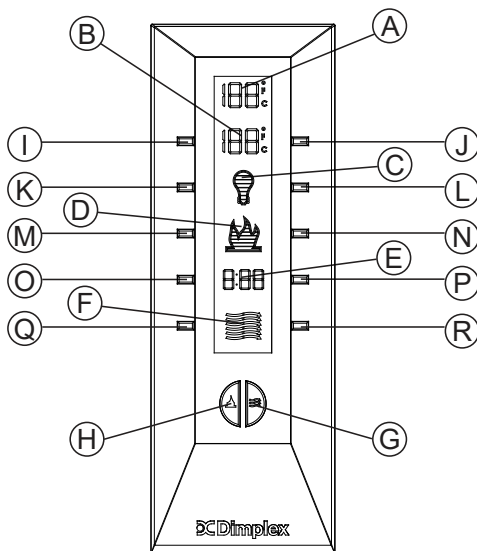

solid. The default setting for the **Fan** is set at low speed.

Press the **H** button to turn the **Fan** function **On**.

Press the **Q** to decrease the **Fan** speed or the **R** to increase the speed.

Press the **H** button to turn the **Fan** function off.

! NOTE: To turn the Flame & Heat/Fan off, press both

control buttons simultaneously.

H. Flame & Heat On/Off Button

Press the **H** button to turn the Flame/Heat function on. When **B** is higher than **A** the heat will come on. To turn the heat off, lower the **B** so that its setting is lower than the **A**. The default temperature setting is 72°F (22°C).

! NOTE: When using the remote control the heater runs

Operation

on a thermostat. Press the **J** or **I** buttons to adjust the set temperature. Once the desired set temperature is reached the heater will turn off. The heater will cycle **On** and **Off** to maintain the desired set temperature.

Disable Heat

If desired, depending on the season, the heater on the unit can be disabled. The unit will operate in the same fashion, with remainder of the controls.

To Disable - Press **J** and **O** at the same time. The temperature setting on the remote will no longer be visible.

! NOTE: The heat will not work in manual controls either.

To Enable - Press **J** and **Q** at the same time. The temperature setting will now be visible again.

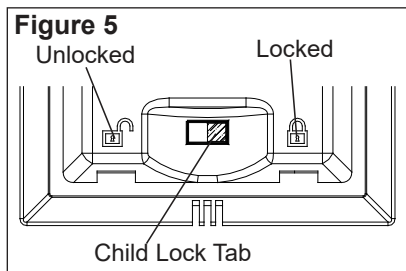

Child Lock (Figure 5)

1. Depress tab on the battery cover on the back of the remote and remove the battery cover.
2. Move Child Lock tab to the right to lock the remote control.
3. Move Child Lock tab back to the left to unlock the remote control.
4. Replace the battery cover.

! NOTE: To temporarily unlock the remote control press (in order) **I** then **J** then **K**.

When the remote control's backlight is illuminated the **Child Lock** is bypassed. When the backlight is off the **Child Lock** is re-activated.

Frequency Interference

If the fireplace does not respond properly to the remote control, the remote operating frequency may have to be reset. The remote control can send another frequency code to the circuit board to eliminate interference.

1. Simultaneously press the **O** button and the **Q** button on the remote control.
2. “**COD**” will appear in place of the sleep timer digits.

Operation

3. Release the **O** button and the **Q** button.
4. Press the Initialization button on the unit (Figure 2C).
5. Press the **H**  button on the remote.

Your remote will now have a different frequency communicating with the fireplace.



Maintenance

 **WARNING:** Disconnect power before attempting any maintenance or cleaning to reduce the risk of fire, electric shock or damage to persons.

! **NOTE:** The fireplace should not be operated with an accumulation of dust or dirt on or in the unit, as this can cause a build up of heat and eventual damage. For this reason the heater must be inspected regularly, depending upon conditions and at least at yearly intervals.

Light Bulb Replacement

Light bulbs need to be replaced when you notice a dark section of the flame or when the clarity and detail of the log ember bed exterior disappears. There are three bulbs under the log set assembly which generate the flames and embers, and two bulbs above that illuminate the log exterior.

Lower Light Bulb Requirements

Quantity of three clear chandelier or candelabra bulbs with an E-12 (small) socket base, 60 Watt rating. Example: GE 60BC or Philips 60CTC. **Do not exceed 60 Watts per bulb.**

Helpful Hints: It is a good idea to



Maintenance

replace all light bulbs at one time if they are close to the end of their rated life. Group replacement will reduce the number of times you need to open the unit to replace light bulbs. Care must be taken when removing the log set as the log set contains LED's and wires.

To access the lower light bulb area:

⚠ CAUTION: Allow at least five minutes for light bulbs to cool off before touching bulbs to avoid accidental burning of skin.

1. Slide fireplace out of mantel.
2. Remove four Phillips screws from right side of trim (Figure 6).
3. Remove trim.

4. Slide glass to right side of fireplace to remove (Figure 6).
5. Pull the front edge of the plastic Log Set or plastic grate up and forward until the rear tab releases from the ledge located at the bottom of the mirror (Figure 7).

! IMPORTANT: Only handle the Log Set Assembly by the Ember Bed or plastic grate.

! NOTE: Log Set Assembly fits tightly into firebox, some force may be necessary to remove.

6. Set Log Set Assembly in front of fireplace.
7. Disconnect the Log Set Assembly's LED wire harness from unit.

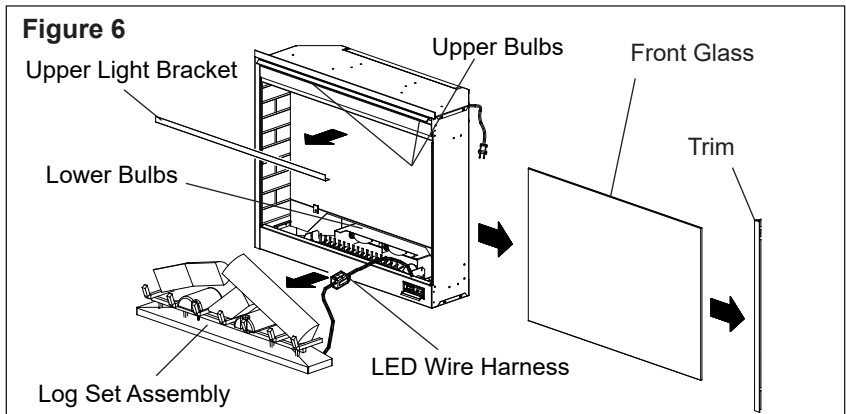



Maintenance

8. Unscrew bulbs counter clockwise.
9. Insert new bulbs and screw in clockwise.
10. Reconnect the LED wire harness.
11. Install the Log Set Assembly by placing the front, bottom edge of the Ember Bed in the track behind the control panel. Once in place, push down on the back edge of the Ember Bed until the rear tab snaps into place under the Mirror (Figure 7).

! NOTE: Ensure the Log Set Assembly is installed tightly under the back ledge to prevent light leakage.

12. Slide front glass back into position and attach trim.

Upper Light Bulb Requirements

Quantity of two (2) clear chandelier or candelabra bulbs with an E-12 (small) socket base, 15 Watt rating. **Do not exceed 15 Watts per bulb.**

To access the upper light bulb area:

⚠ CAUTION: Allow at least five minutes for light bulbs to cool off before touching bulbs to avoid

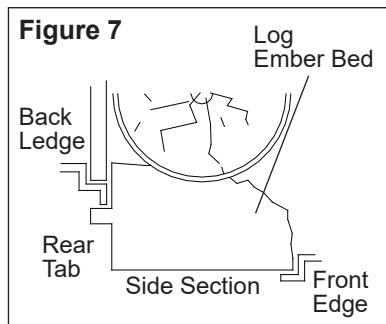

accidental burning of skin.

1. Slide fireplace out of mantel.
2. Remove four Phillips screws from right side of trim (Figure 6).
3. Remove trim.
4. Slide glass to the right side of the fireplace to remove (Figure 6).
5. Remove Upper Light Bracket (Figure 6).
6. Upper bulbs are located in the upper left and upper right corners of the fireplace.
7. Unscrew bulbs counter clockwise.
8. Insert new bulbs and screw in clockwise.
9. Re-install Upper Light Bracket.
10. Slide front glass back into position and attach trim.



Maintenance

Glass Cleaning

The glass is cleaned in the factory during the assembly operation. During shipment, installation, handling, etc., the glass may collect dust particles; these can be removed by dusting lightly with a clean dry cloth.

To remove fingerprints or other marks, the glass can be cleaned with a damp cloth. To prevent scratching, do not use abrasive cleaners or spray liquids on the glass surface.

Fireplace Surface Cleaning

Use a cloth dampened with warm water only to clean painted surfaces of the electric fireplace. Do not use abrasive cleaners.



Warranty

Products to which this limited warranty applies

This limited warranty applies to the following model of your newly purchased Dimplex electric fireplace **DF3015** and to newly purchased Dimplex fireplace surrounds (mantels) and trims. This limited warranty applies only to purchases made in any province of Canada *except* for Yukon Territory, Nunavut, or Northwest Territories or in any of the 50 States of the USA (and the District of Columbia) *except* for Hawaii and Alaska. This limited warranty applies to the original purchaser of the product only and is not transferable.

Products excluded from this limited warranty

Light bulbs are not covered by this limited warranty and are the sole responsibility of the owner/purchaser. Products purchased in Yukon Territory, Nunavut, Northwest Territories, Hawaii, or Alaska are not covered by this limited warranty. Products purchased in these States, provinces, or territories are sold AS IS without warranty or condition of any kind (including, without limitation, any implied warranties or conditions of merchantability or fitness for a particular purpose) and the entire risk of as to the quality and performance of the products is with the purchaser, and in the event of a defect the purchaser assumes the entire cost of all necessary servicing or repair.

What this limited warranty covers and for how long

Products, other than fireplace surrounds (mantels) and trims, covered by this limited warranty have been tested and inspected prior to shipment. Subject to the provisions of this warranty, Dimplex

warrants such products to be free from defects in material and workmanship for a period of 5 years from the date of the first purchase of such products as follows: (a) a repair or replacement warranty on defective products or parts, including in-home services, for the first 1 year following the date of first purchase; and (b) thereafter, a replacement of parts warranty on defective products and parts (with no in-home services) for the 4 year period commencing on the first anniversary of first purchase and ending on the fifth anniversary of the date of first purchase.

Dimplex fireplace surrounds (mantels) and trims covered by this limited warranty have been tested and inspected prior to shipment and, subject to the provisions of this warranty, Dimplex warrants such products to be free from defects in material and workmanship for a period of 1 year from the date of first purchase of such products. Warranty services do not include in-home services.

The above section is a summary only of your warranty rights. Please review the remaining provisions of this warranty for your specific rights.

The limited 5 year warranty period for products other than fireplace surrounds (mantels) and trims and the limited 1 year warranty period for fireplace surrounds (mantels) and trims also applies to any implied warranties that may exist under applicable law. Some jurisdictions do not allow limitations on how long an implied warranty lasts, so the above limitation may not apply to the purchaser.

What this limited warranty does not cover

This limited warranty does not apply to products that have been repaired (except



Warranty

by Dimplex or its authorized service representatives) or otherwise altered. This limited warranty does further not apply to defects resulting from misuse, abuse, accident, neglect, incorrect installation, improper maintenance or handling, or operation with an incorrect power source.

What you must do to get service under this limited warranty

Defects must be brought to the attention of Dimplex Technical Service by contacting Dimplex at 1-888-DIMPLEX (1-888-346-7539), or 1367 Industrial Road, Cambridge Ontario, Canada N3H 4W3. Please have proof of purchase, catalogue/model and serial numbers available when calling. Limited warranty service requires a proof of purchase of the product.

What Dimplex will do in the event of a defect

In the event a product or part covered by this limited warranty is proven to be defective in material or workmanship during (i) the 5 year limited warranty period for products other than fireplace surrounds (mantels) and trims, and (ii) the 1 year limited warranty period for surrounds (mantels) and trims, you have the following rights:

- Limited warranty service will be performed solely by dealers or service agents of Dimplex authorized to provide limited warranty services.
- **For products (other than surrounds (mantels) and trims) for the period ending at midnight on the first anniversary of the date of first purchase**, Dimplex will in its sole discretion either repair or replace such defective product or part without

charge. If Dimplex is unable to repair or replace such product or part, or if repair or replacement is not commercially practicable or cannot be timely made, Dimplex may, in lieu of repair or replacement, choose to refund the purchase price for such product or part. *This limited warranty entitles the purchaser to on-site or in-home warranty services.* Accordingly, Dimplex will be responsible for all labour and transportation costs associated with the repair or replacement of the product or part except as follows: (i) charges may be levied for travel costs incurred to travel to the purchaser's site where the product is located if the purchaser's site is beyond 30 miles (48 km) from the closest service depot of Dimplex's dealer or service agent; and (ii) the purchaser is solely responsible for providing clear access to all serviceable parts of the product.

- **For products (other than surrounds (mantels) and trims) for the period commencing at 12:01 a.m. on the day after the first anniversary of the first purchase and ending at midnight on the fifth anniversary of the date of first purchase**, this limited warranty entitles the purchaser to replacement parts only without charge. If Dimplex is unable to replace such part, or if replacement is not commercially practicable or cannot be timely made, Dimplex may, in lieu of replacement, choose to refund the purchase price for such part. The purchaser shall not be entitled to on-site or in-home warranty services. The purchaser shall be responsible



Warranty

for all expenses incurred for the removal of the part and installation of the replacement part including, without limitation, all shipping costs and transportation costs to and from the authorized dealer's or service agent's place of business and all labour costs. Such costs shall not be the responsibility of Dimplex.

- **For surrounds (mantels) and trims for the period ending at midnight on the first anniversary of the date of first purchase**, Dimplex will in its sole discretion either repair or replace such defective surrounds (mantels) and trims or part thereof without charge. If Dimplex is unable to repair or replace such product or part, or if repair or replacement is not commercially practicable or cannot be timely made, Dimplex may, in lieu of repair or replacement, choose to refund the purchase price for such product or part. The purchaser shall not be entitled to on-site or in-house services. The purchaser is responsible for all expenses incurred for repair or replacement of such product or part including, without limitation, all shipping costs and transportation costs to and from the authorized dealer's or service agent's business and all labour costs. Such costs shall not be the responsibility of Dimplex.
- On-site or in-home services not provided under this warranty may be performed at the purchaser's specific request and expense at Dimplex's then-current rates for such services.

What Dimplex and its dealers and service agents are also not responsible for:

IN NO EVENT WILL DIMPLEX, OR ITS DIRECTORS, OFFICERS, OR AGENTS, BE LIABLE TO THE PURCHASER OR ANY THIRD PARTY, WHETHER IN CONTRACT, IN TORT, OR ON ANY OTHER BASIS, FOR ANY INDIRECT, SPECIAL, PUNITIVE, EXEMPLARY, CONSEQUENTIAL, OR INCIDENTAL LOSS, COST, OR DAMAGE ARISING OUT OF OR IN CONNECTION WITH THE SALE, MAINTENANCE, USE, OR INABILITY TO USE THE PRODUCT, EVEN IF DIMPLEX OR ITS DIRECTORS, OFFICERS, OR AGENTS HAVE BEEN ADVISED OF THE POSSIBILITY OF SUCH LOSSES, COSTS OR DAMAGES, OR IF SUCH LOSSES, COSTS, OR DAMAGES ARE FORESEEABLE. IN NO EVENT WILL DIMPLEX, OR ITS OFFICERS, DIRECTORS, OR AGENTS BE LIABLE FOR ANY DIRECT LOSSES, COSTS, OR DAMAGES THAT EXCEED THE PURCHASE PRICE OF THE PRODUCT.

SOME JURISDICTIONS DO NOT ALLOW THE EXCLUSION OR LIMITATION OF INCIDENTAL OR CONSEQUENTIAL DAMAGES, SO THE ABOVE LIMITATION OR EXCLUSION MAY NOT APPLY TO THE PURCHASER.

How State and Provincial law apply

This limited warranty gives you specific legal rights, and you may also have other rights which vary from jurisdiction to jurisdiction. The provisions of the United Nations Convention on Contracts for the Sale of Goods shall not apply to this limited warranty or the sale of products covered by this limited warranty.



Replacement Parts

Log Set Assembly	0439070100RP
Flicker Motor	3000240200KIT
Heater Assembly	2200490600RP
Cutout	2300270310RP
Main On/Off Switch	2800070700RP
Remote Switch Board	3000300300RP
Cord Set	4100040500RP
Mirror	5900680100RP
Front Glass	5900310400RP
Remote Control	3000890100RP
Remote Receiver	3000880100RP
Flicker Rod	5900080700RP
Wire Harness - 1 socket	2500150200RP
Fireplace Foot	8800090100RP

1-888-346-7539 | www.dimplex.com

In keeping with our policy of continuous product improvement, we reserve the right to make changes without notice.

© 2019 Glen Dimplex Americas

Glen Dimplex
AMERICAS

Enhancing the moments that matter in life