



Owner's Manual











Models SPF1808L-IR (6910280100)
SPF2308L-IR (6910290100)

IMPORTANT SAFETY INFORMATION: Read this manual before attempting to install or use the Dimplex Electric Fireplace. Always comply with the warnings and safety instructions contained in this manual to prevent personal injury or property damage.



To view the full line of Dimplex products, visit www.dimplex.com



Table of Contents

 Welcome	3
 IMPORTANT INSTRUCTIONS.....	4
 Specifications	6
 Installation	7
 Operation.....	8
 Maintenance.....	11
 Troubleshooting.....	13
 Warranty	14
 Technical Support.....	16

Conventions used in this manual:

-  **NOTE:** Procedures and techniques considered important enough to emphasize.
-  **CAUTION:** Procedures and techniques which, if not carefully followed, will result in damage to the equipment.
-  **WARNING:** Procedures and techniques which, if not carefully followed, will expose the user to the risk of fire, serious injury, or death.

Welcome

Thank you for purchasing a Dimplex Electric Fireplace. Please use our convenient online registration page to record your model and serial numbers for future reference at:

www.dimplex.com/register

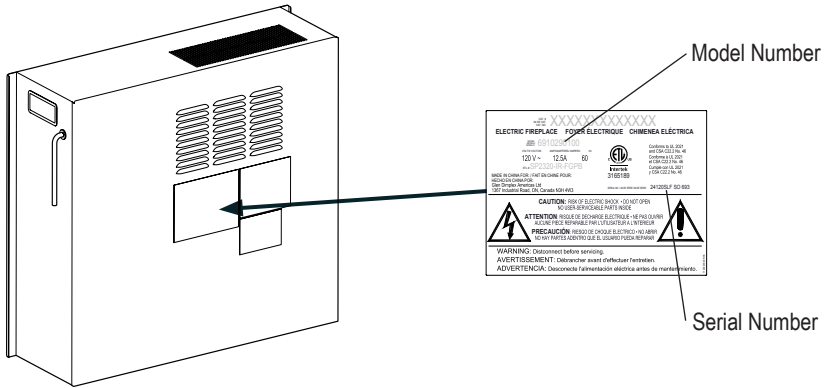

⚠ CAUTION: Read all instructions and warnings carefully before starting installation. Failure to follow these instructions may result in a possible electric shock or fire hazard and will void the warranty.



NO NEED TO RETURN TO THE STORE

Questions with operation or assembly? Require Parts Information?
Product Under Manufacturer's Warranty?

Contact us at:  www.dimplex.com/customer_support
For Troubleshooting and Technical Support

OR  Toll-Free 1-888-346-7539

In order to better serve you, please have your model and serial numbers ready or register your product online before calling (see above).



IMPORTANT INSTRUCTIONS

Read this manual before attempting to install or use the electric fireplace. Always comply with the warnings and safety instructions contained in this manual to prevent personal injury or property damage.

When using electrical appliances, basic precautions should always be followed to reduce the risk of fire, electric shock and injury to persons, including the following:

- This appliance is hot when in use. To avoid burns, do not let skin touch hot surfaces. Keep combustible materials, such as furniture, pillows, bedding, papers, clothes and curtains at least 3 ft. from the front of this appliance and keep away from sides and rear.
- Extreme caution is necessary when any heater is used by, or near, children or invalids, and whenever the heater is left operating and unattended.
- Do not operate any heater with a damaged cord or plug, after the appliance malfunctions, or if it has been dropped or damaged in any manner. Disconnect from power and call Technical Service or have it inspected by qualified electrician.
- To disconnect the fireplace, turn the controls off, then remove the plug from the outlet.
- Do not use outdoors.
- Do not insert or allow foreign objects to enter any ventilation or exhaust opening as this may cause an electric shock or fire, or damage the fireplace.
- All electrical heaters have hot and arcing or sparking parts inside. Do not use it in areas where gasoline, paint or flammable liquids are used or stored.
- Use this appliance only as described in the manual. Any other use not recommended by the manufacturer may cause fire, electric shock or injury to persons.
- If possible, always unplug this appliance when not in use.
- Any repairs to this fireplace should be carried out by a qualified service person.
- Under no circumstances should this fireplace be modified. Parts having to be removed for servicing must be replaced prior to operating this fireplace again.
- This heater is not intended for use in bathrooms, laundry areas and similar indoor locations. Never place heater where it may fall into a bathtub or other water container.
- Always connect to properly grounded outlets.



SAVE THESE INSTRUCTIONS



IMPORTANT INSTRUCTIONS

- Do not run cord under carpeting. Do not cover cord with throw rugs, runners or the like. Arrange cord away from traffic areas and where it will not be tripped over.
- Always plug heaters directly into a wall outlet/receptacle. Never use with an extension cord or relocatable power tap (outlet/power strip).
- To prevent a possible fire, do not block air intakes or exhaust in any manner. Do not use on soft surfaces, like bed, where opening may become blocked.
- There is a resettable cutout switch inside the heater. Should the heater overheat, the cutout will turn the fireplace heater off. To reset the cutout switch unplug the unit and wait 5 minutes before plugging it back in.

 **CAUTION:** If you need to continuously reset the cutout, unplug the unit and call Technical Support.

- Remote control contains small batteries. Keep away from children. If swallowed, seek medical attention immediately.

FCC Compliance

This equipment has been tested and found to comply with the limits for Class B digital devices, pursuant to part 15 of the FCC rules. These limits are designed to provide reasonable protection against harmful interference in a residential installation. The equipment generates, uses and can radiate radio frequency energy and, if not installed and used in accordance with the instructions, may cause harmful interference to radio or television reception, which can be determined by turning the equipment off and on. The user is encouraged to try and correct the interference by one or more of the following measures:

- Reorient or relocate the receiving antenna
- Increase the separation between the equipment and the receiver
- Connect the equipment into an outlet on a circuit different from that to which the receiver is connected
- Consult the dealer or an experienced radio/TV technician for help

This device complies with Part 15 of the FCC rules. Operation is subject to the following two conditions:

1. This device may not cause harmful interference, and
2. This device must accept any interference received, including interference that may cause undesired operation.

Modifications not approved by the party responsible for compliance could void user's authority to operate the equipment. This Class B digital apparatus complies with Canadian ICES-003.

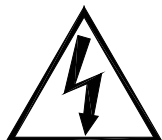

CAUTION
RISK OF ELECTRIC SHOCK
DO NOT OPEN
NO USER-SERVICEABLE PARTS INSIDE



Specifications

Electrical

Volts: 120 V~, 60 Hz
Amps: 12.5 A
Watts: 1500 W
Heating: Infrared
Wiring: Plug-In
Bulb Type: LED

Approvals



Dimensions

SPF1808L-IR

Width: 19" (480 mm)
Height: 17" (430 mm)
Depth: 8-1/2" (215 mm)
Weight: 28.6 lbs (13 kg)

Mantel Opening

Width: 18-1/4" (462 mm)
Height: 16-1/2" (419 mm)

SPF2308L-IR

Width: 24-1/4" (615 mm)
Height: 20-1/2" (520 mm)
Depth: 8-1/2" (215 mm)
Weight: 33.1 lbs (15 kg)

Mantel Opening

Width: 23-1/4" (590 mm)
Height: 20-1/8" (521 mm)

Installation

The fireplace insert is intended for use with a mantel. Make sure you can access the back of the mantel as your fireplace is installed from the back.

Follow the mantel instructions for proper fireplace installation, if available.

! NOTE The fireplace insert needs to be secured to the mantel before it is used.

The electric fireplace air intake is on the back and top of the unit. Do not seal the back of the mantel or place tight against a wall.

When choosing a final location for your fireplace, make sure you will have clear access to grounded electrical outlet.

If installing the unit in a custom built mantel ensure that there is clearance around the fireplace insert as per Figure 1.

Figure 1

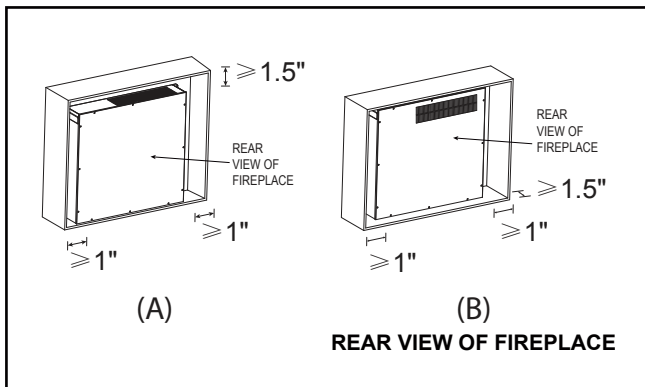

Grounding Instructions

- This product is equipped with a cord having an equipment-grounding conductor and a grounding plug. The plug must be plugged into an appropriate outlet that is properly installed and grounded in accordance with all local codes and ordinances.
- This heater is for use on 120 volts. The cord has a plug as shown.
- A 15 Amp, 120 Volt circuit is required. A dedicated circuit is preferred, but not essential in all cases. A dedicated circuit will be required if, after installation, the circuit breaker trips or the fuse blows on a regular basis when the heater is operating. Additional appliances on the same circuit may exceed the current rating of the circuit breaker.

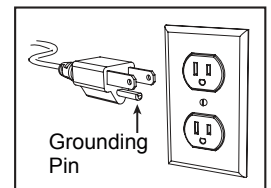

Operation

The fireplace can be operated with the multi-function IR remote control or from the control buttons located on the top-right corner of the fireplace.

The remote control has an operating range of up to 5.8m / 19ft.

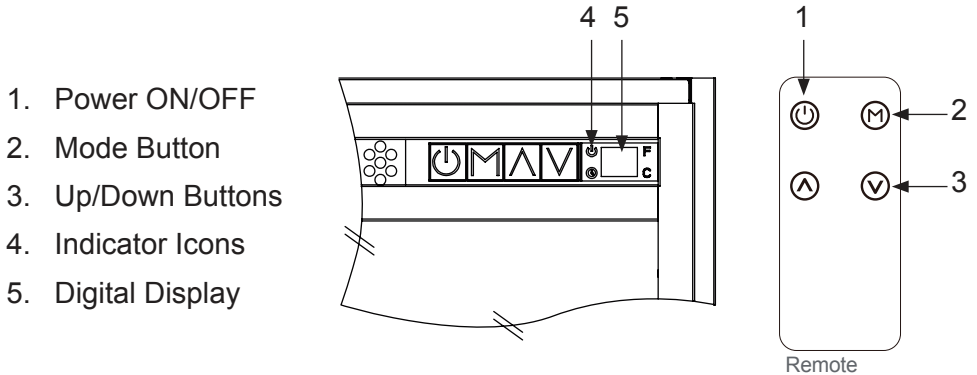

Power ON/OFF

The **ON/OFF** button turns the fireplace ON and OFF. When the fireplace is OFF, power indicator icon is lit red. Power icon turns green when power is ON.

The fireplace has a built-in memory function, when turned back on, it starts at the last used settings except for the timer. If the fireplace insert is disconnected from the main power source, it reverts to the default settings.

! NOTE: Each time the fireplace insert is plugged in, it runs an internal program check and the heater will turn on for 5 seconds.

Operation

Mode Button

Press the **Mode Button** to cycle through Heat, Timer or Flame Brightness set mode.

Heat Set Mode

When active press **Up or Down Button** to set temperature from 59°F (15°C) to 86°F (30°C), ON and OF. 'ON' means the heater operates continuously. 'OF' (OFF) means only the fan will operate the heater will be off.

! **NOTE:** When the heat is turned off, the heating element will shut down first then the fan after 20 seconds.

Changing the Temperature Unit (°F ↔ °C):

Press and hold the **Mode Button** on the fireplace for 3 seconds to change the displayed temperature units.

! **NOTE:** This function cannot be set with the remote control.

Timer Set Mode

When timer mode is activated 0.0 appears on the display and the timer indicator light is lit yellow. Press **Up or Down Button** to set the sleep timer by scrolling through the following:

0.0 (off), 0.5 (30 min), 1.0 (1h), 1.5, 2.0, 2.5 ...9.0.

The fireplace shuts off after the selected time period. Switching the fireplace off with the Power Button clears any timer setting.

Flame Brightness Set Mode

When set in this mode, use the Up and Down Buttons to select from the available 6 options: F0 (no flames), F1, F2, F3, F4 and F5 (the brightest flames and ember bed).

Operation

^ v UP/DOWN Buttons

These buttons are used to adjust heater, timer and flame settings.

Child Lock Enable & Disable:

When the fireplace is ON, press and hold the **Power ON/OFF Button** on the fireplace for 10 seconds. Three beeps and flashing 'E3' indicate that the Child Lock function is activated. The Mode, Up or Down buttons will not operate and 'E3' will be displayed when pressed. The power ON/OFF button will also not operate, but only beeps will indicate that the child lock has been activated.

To disable the Child Lock, again press and hold the **Power ON/OFF Button** for 10 seconds.

! NOTE: This function can only be done through the fireplace controls, not using the remote control.



Maintenance

Remote Control

The battery compartment is located on the back end of the remote control.

- Press the small tab inward as you slide the battery door open.
- Insert the included or a new CR2025 lithium battery, ensuring the polarities of the battery match the inside of the battery compartment.
- Re-insert battery door.

! NOTE: The battery should be removed if the product is to be left unused for a long time.

⚠ CAUTION: Non-rechargeable battery is not to be recharged. Exhausted battery is to be removed from product and properly disposed of.

Replacing the Remote Control Batteries

- When replacing the battery, replace with a new battery of the correct type.
- Do not mix old and new batteries.

Disposal of Used Batteries



Batteries may contain hazardous substances that could be endangering to environment and human health.

- This symbol marked on the battery and/or packaging indicates that used batteries shall not be treated as municipal waste. Instead they shall be left at the appropriate collection point for recycling.
- By ensuring the used batteries are properly disposed of, you will help prevent potential negative consequences for the environment and human health. The recycling of materials will help to conserve natural resources.

For more information about collection and recycling of used batteries, please contact your local municipality, your waste disposal service or the point of sale where you purchased this item.



Maintenance

- Clean the metal trim using a water-dampened soft, clean cloth. **DO NOT** use brass polish or household cleaners as these products will damage the metal trim.
 - The motors used on the fan and the flame generator assembly are pre-lubricated for extended bearing life and require no further lubrication. However, periodic cleaning/vacuuming of the fan/heater and air intake/output vents is recommended. The heater should be cleaned and inspected regularly, depending on conditions, and at least at yearly intervals.
- ⚠ WARNING:** Any electrical repairs of this unit should be carried out by a licensed electrician in accordance with national and local codes.
- ⚠ WARNING:** Disconnect power by unplugging the power and allowing heater to cool before attempting any maintenance or cleaning to reduce the risk of fire, electric shock, or injury.
- ! NOTE:** When the heater is not in use, the heater should be stored in a dry location, away from possible damage. The power cord should be stored properly to avoid contact with hot or sharp objects.



Troubleshooting

PROBLEM	POSSIBLE CAUSE	SOLUTION
No power, logs do not glow.	The unit does not have power.	Check that unit is plugged into a standard 120 volt outlet. Then make sure power is set at "ON" position.
E1 displayed on control panel.	The overheat protection device has been engaged.	Unplug unit, wait 5-10 minutes, then the sensor will reset itself. Plug the unit back in and turn on the heater. If the problem persists, call customer service.
E2 displayed on control panel.	The ambient temperature sensor is broken or not working correctly.	Unplug unit, wait 5-10 minutes, then the sensor will reset itself. Plug the unit back in and turn on the heater. If the problem persists, call customer service.
E3 displayed on control panel.	Child lock function activate.	To inactivate the Child Lock function, holding the POWER button for 10 seconds.
Fan motor continues to blow after unit is powered off.	Normal operation	This is a standard feature; the blower runs for an additional 20 seconds to ensure heat will not be trapped inside the unit.
Power cord gets warm to the touch.	Normal operation.	This is normal for a heater appliance as it requires more current to operate. Check the connections of the appliance cord and the outlet. Make sure the plug fits tightly into the outlet. During use, check the plug and outlet frequently to determine if it is HOT; if so, discontinue use of the appliance and consult with a qualified electrician to check or change the overheating outlet(s).



Warranty

One Year Limited Warranty

Products to which this limited warranty applies

This limited warranty applies to your newly purchased Dimplex electric compact insert. This limited warranty applies only to purchases made in any province of Canada except for Yukon Territory, Nunavut, or Northwest Territories or in any of the 50 States of the USA (and the District of Columbia) except for Hawaii and Alaska. This limited warranty applies to the original purchaser of the product only and is not transferable.

Products excluded from this limited warranty

Light bulbs are not covered by this limited warranty and are the sole responsibility of the owner/purchaser. Products purchased in Yukon Territory, Nunavut, Northwest Territories, Hawaii, or Alaska are not covered by this limited warranty. Products purchased in these States, provinces, or territories are sold AS IS without warranty or condition of any kind (including, without limitation, any implied warranties or conditions of merchantability or fitness for a particular purpose) and the entire risk of as to the quality and performance of the products is with the purchaser, and in the event of a defect the purchaser assumes the entire cost of all necessary servicing or repair.

What this limited warranty covers and for how long

Products covered by this limited warranty have been tested and inspected prior to shipment and, subject to the provisions of this warranty, Glen Dimplex Americas Ltd. (herein called Glen Dimplex Americas)

warrants such products to be free from defects in material and workmanship for a period of 12 months from the date of the first purchase of such product.

The limited 12 month warranty period also applies to any implied warranties that may exist under applicable law. Some jurisdictions do not allow limitations on how long an implied warranty lasts, so the above limitation may not apply to the purchaser.

What this limited warranty does not cover

This limited warranty does not apply to products that have been repaired (except by Glen Dimplex Americas or its authorized service representatives) or otherwise altered. This limited warranty does further not apply to defects resulting from misuse, abuse, accident, neglect, incorrect installation, improper maintenance or handling, or operation with an incorrect power source.

What you must do to get service under this limited warranty

Defects must be brought to the attention of Technical Service at 1-888-346-7539. Please have proof of purchase, catalogue/model and serial numbers available when calling. Limited warranty service requires a proof of purchase of the product.

What Glen Dimplex Americas will do in the event of a defect

In the event a product or part covered by this limited warranty is proven to be defective in material or workmanship during the 12 month limited warranty period you have the following rights:

- Glen Dimplex Americas will in its sole



Warranty

discretion either repair or replace such defective product or part without charge. If Glen Dimplex Americas is unable to repair or replace such product or part, or if repair or replacement is not commercially practicable or cannot be timely made, Glen Dimplex Americas may, in lieu of repair or replacement, choose to refund the purchase price for such product or part.

- Limited warranty service will be performed solely by dealers or service agents of Glen Dimplex Americas authorized to provide limited warranty services.
- The purchaser is responsible for removal and transportation of such product or part (and any repaired or replacement product or part) to and from the authorized dealer's or service agent's place of business.
- This limited warranty does not entitle the purchaser to on-site or in-home services. On-site or in-home services may be performed at the purchaser's specific request and expense at Glen Dimplex Americas then-current rates for such services.
- Glen Dimplex Americas will not be responsible for, and the limited warranty services shall not include, any expense incurred for installation or removal of the product or part (or any replacement product or part) or any labour or transportation costs. Such costs shall be the purchaser's responsibility.

How State and Provincial law apply

This limited warranty gives you specific legal rights, and you may also have other

rights which vary from jurisdiction to jurisdiction. The provisions of the United Nations Convention on Contracts for the Sale of Goods shall not apply to this limited warranty or the sale of products covered by this limited warranty.

What Glen Dimplex Americas and its dealers and service agents are also not responsible for:

IN NO EVENT WILL GLEN DIMPLEX AMERICAS, OR ITS DIRECTORS, OFFICERS, OR AGENTS, BE LIABLE TO THE PURCHASER OR ANY THIRD PARTY, WHETHER IN CONTRACT, IN TORT, OR ON ANY OTHER BASIS, FOR ANY INDIRECT, SPECIAL, PUNITIVE, EXEMPLARY, CONSEQUENTIAL, OR INCIDENTAL LOSS, COST, OR DAMAGE ARISING OUT OF OR IN CONNECTION WITH THE SALE, MAINTENANCE, USE, OR INABILITY TO USE THE PRODUCT, EVEN IF GLEN DIMPLEX AMERICAS OR ITS DIRECTORS, OFFICERS, OR AGENTS HAVE BEEN ADVISED OF THE POSSIBILITY OF SUCH LOSSES, COSTS OR DAMAGES, OR IF SUCH LOSSES, COSTS, OR DAMAGES ARE FORESEEABLE. IN NO EVENT WILL GLEN DIMPLEX AMERICAS, OR ITS OFFICERS, DIRECTORS, OR AGENTS BE LIABLE FOR ANY DIRECT LOSSES, COSTS, OR DAMAGES THAT EXCEED THE PURCHASE PRICE OF THE PRODUCT.

SOME JURISDICTIONS DO NOT ALLOW THE EXCLUSION OR LIMITATION OF INCIDENTAL OR CONSEQUENTIAL DAMAGES, SO THE ABOVE LIMITATION OR EXCLUSION MAY NOT APPLY TO THE PURCHASER.



Technical Service

Contact our friendly customer service team for technical and trouble-shooting support. Make sure you have your sales receipt, location of purchase, and the model and serial number of your product.

1-888-346-7539 | www.dimplex.com/contact_us

In keeping with our policy of continuous product improvement, we reserve the right to make changes without notice.

Glen Dimplex Americas

1-888-346-7539 | www.dimplex.com

© 2020 Glen Dimplex Americas

Glen Dimplex 
AMERICAS

Enhancing the moments that matter in life